



WORLD  
PRECISION  
INSTRUMENTS

# INSTRUCTION MANUAL

## STX2-PLUS

*for use with EVOM3 Epithelial Voltohmmeter*

Serial No. \_\_\_\_\_



[www.wpiinc.com](http://www.wpiinc.com)

082620



## CONTENTS

|  |    |
|--|----|
| ABOUT THIS MANUAL .....                            | 1  |
| INTRODUCTION .....                                 | 1  |
| Unpacking .....                                    | 2  |
| OPERATING INSTRUCTIONS.....                        | 3  |
| Positioning Electrode in a Culture Cup.....        | 3  |
| Stable Repeatable Readings .....                   | 3  |
| Ease of Use .....                                  | 3  |
| Adjusting the Length of the Electrodes .....       | 4  |
| MAINTENANCE .....                                  | 5  |
| Cleaning/Maintaining the STX2-PLUS Electrodes..... | 5  |
| Disinfecting the STX2-PLUS Electrodes .....        | 5  |
| Sterilizing the STX2-PLUS Electrode .....          | 6  |
| Rechloriding the Electrodes .....                  | 6  |
| Storing the Electrodes .....                       | 6  |
| Testing the STX2-PLUS Electrodes.....              | 7  |
| ACCESSORIES.....                                   | 7  |
| TROUBLESHOOTING .....                              | 8  |
| APPENDIX A: KCL TESTING MIXTURES.....              | 9  |
| APPENDIX B: COMPATIBLE INSERTS AND PLATES .....    | 9  |
| WARRANTY .....                                     | 11 |
| Claims and Returns .....                           | 11 |
| Repairs.....                                       | 11 |

*Copyright © 2020 by World Precision Instruments. All rights reserved. No part of this publication may be reproduced or translated into any language, in any form, without prior written permission of World Precision Instruments, Inc.*



## ABOUT THIS MANUAL

The following symbols are used in this guide:



This symbol indicates a CAUTION. Cautions warn against actions that can cause damage to equipment. Please read these carefully.



This symbol indicates a WARNING. Warnings alert you to actions that can cause personal injury or pose a physical threat. Please read these carefully.

NOTES and TIPS contain helpful information.



Fig. 1—The STX2-PLUS electrode is designed for use with the EVOM3 meter.

## INTRODUCTION

The **STX2-PLUS** electrode can be used with the **EVOM3** and is designed to facilitate measurements of membrane voltage and resistance (TEER) of cultured epithelia directly in 12- and 24-well tissue culture plates. The electrode incorporates an adjustable pair of probes, 5 mm tall, 4 mm wide and 0.7 mm in thickness. Each probe has an outer (current) and an inner (voltage) electrode.

For 12- or 24-well measurements, the **STX2-PLUS** electrode is capable of making precise measurements. The **STX2-PLUS** is designed primarily for 24-well inserts, and it can be used with 24-well HTS plates (Corning 3378) and 12-well inserts (Corning 3460) with good results, as long as the placement is consistent. Consistent electrode placement and mechanical stability are essential for consistent resistance results. Try to keep the fluid levels and fluid temperatures constant. The use of a warming plate can add to measurement items and reduce CO<sub>2</sub> out gassing during readings. CO<sub>2</sub> out gassing can change the pH of the media and sharply increase a resistance reading.

---

## Unpacking

Upon receipt of this instrument, make a thorough inspection of the contents and check for possible damage. Missing cartons or obvious damage to cartons should be noted on the delivery receipt before signing. Concealed damage should be reported at once to the carrier and an inspection requested. Please read the section entitled "Claims and Returns" on page 11 of this manual. Please contact WPI Customer Service if any parts are missing at 941.371.1003 or [customerservice@wpiinc.com](mailto:customerservice@wpiinc.com).

**Returns:** Do not return any goods to WPI without obtaining prior approval (RMA # required) and instructions from WPI's Returns Department. Goods returned (unauthorized) by collect freight may be refused. If a return shipment is necessary, use the original container, if possible. If the original container is not available, use a suitable substitute that is rigid and of adequate size. Wrap the instrument in paper or plastic surrounded with at least 100 mm (four inches) of shock absorbing material. For further details, please read the section entitled "Claims and Returns" on page 11 of this manual.

## OPERATING INSTRUCTIONS

### Positioning Electrode in a Culture Cup

Proper placement of the electrode in the cell is critical to making accurate measurements. The **STX2-PLUS** electrode is designed to facilitate measurements of membrane voltage and resistance of cultured epithelia in tissue culture wells. The lengths of the electrodes are unequal allowing the longer (external) electrode to touch the bottom of the dish containing the external culture media while preventing the shorter (internal electrode) from reaching the bottom of the tissue culture cup or insert (see Fig. 1) below). This feature ensures proper repeatable positioning between the electrode and the cell layer in the cup during the trans membrane measurement. The reproducibility of the measurements is significantly improved.

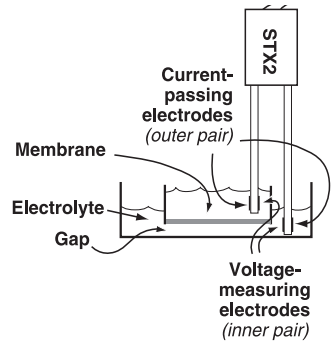

Fig. 2— (Right) Electrodes in solution.

### Stable Repeatable Readings

This new electrode design sets the correct depth and centering of the electrode elements. Once placed and released, movement ceases, the **EVOM3** readings become more stable, negating any need to make multiple measurements.

### Ease of Use

The **STX2-PLUS** is designed for use with Corning 347X 24-well plates or Millipore hanging inserts. The apical volume is 250  $\mu\text{L}$ , and the basal volume is 750 to 1000  $\mu\text{L}$ .

Insert the outer electrode into the basal access, center the lower adjustment ring onto the upper edge of the insert and let the electrode stand on its own. The electrode legs no longer need to flex or be inserted at an angle (Fig. 4). The electrode placement is stable and repeatable.

\*For 24-well HTS plates, keep the basal electrode centered in the basal access.

\*For 12-well inserts, the **STX2-PLUS** must be hand held.

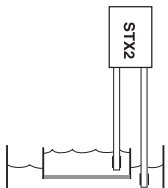

Fig. 3—Correct

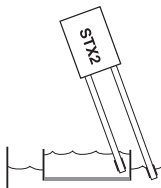

Fig. 4—Angle variance

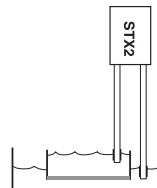

Fig. 5—Depth variance

## Adjusting the Length of the Electrodes

1. Firmly grasp the white adjustment nut at the end of the electrode body with one hand. With the other hand hold the shaft of the electrode body. Rotate the nut clockwise to shorten the electrodes. Rotate it counter-clockwise to lengthen the electrodes.

**NOTE:** The ring should extend a little beyond the steel surface. This allows the step in the ring to engage the outer edge of the insert (or the tri supports of a hanging insert).



*Fig. 6—Rotate the nut to adjust the length of the electrodes.*



*Fig. 7—The electrode length is properly adjusted.*

2. Align the electrodes with the well inserts and position the **STX2-PLUS** over the well so that it rests securely in an upright position. (Images shown with a Corning 3470 24-well insert and plate. For greater stability, rest the cable on the tabletop. For other plates and inserts, center the electrodes and the weight holds the electrode in place when making measurement readings.)



*Fig. 8—The outer electrode reaches close to the bottom of the well plate, and the inner electrode does not touch the membrane.*



*Fig. 9—The STX2-PLUS sits securely over a well insert.*



## MAINTENANCE

Electrodes must be properly cleaned, sterilized and stored.



**CAUTION:** Do not flame electrodes. Doing so will cause them to melt.

## Cleaning/Maintaining the STX2-PLUS Electrodes

**IMPORTANT!** With the use of DMEM, the electrode surface will become coated with protein or other foreign materials. This build-up, or contamination, will degrade the performance of the system. After every use, rinse the STX electrodes with distilled water and store them dry. Periodically clean your STX electrodes with Tergazyme, Enzol or Endozyme proteolytic detergents. (These detergents are manufactured by Alconox, Johnson & Johnson, Ruhof.)

1. Rinse with the electrodes with distilled water and dry them.
2. Make a 1% solution of Tergazyme according to the manufacturer's instructions.
3. Suspend the tips of the electrodes in the Tergazyme solution, with the exposed electrode surfaces fully immersed. During soaking, you can brush the surfaces of the electrodes with a soft brush (like a toothbrush), if desired. The soaking time varies according to your maintenance schedule and the frequency of your cleaning.
  - Soak the electrodes overnight when the electrodes have not been on a routine maintenance cleaning schedule.
  - Soak 60 minutes if you are on a weekly cleaning schedule.
  - Soak 10-30 minutes if you clean your electrodes daily.
4. Rinse the electrodes well with distilled or de-ionized water. Allow them to air dry and store the electrodes dry away from exposure to sunlight.

## Disinfecting the STX2-PLUS Electrodes

The **STX2-PLUS** electrodes are resistant to most methods of low temperature chemical disinfection. A solution of 5% sodium hypochlorite (undiluted household bleach) is a good choice. Ortho-phthalaldehyde (Cidex OPA or Rapicide OPA), 30/70 ethanol or 30/70 isopropyl alcohol are also acceptable.

The **STX2-PLUS** electrodes require a 10-15 minute soak in a solution of 5% sodium hypochlorite (undiluted household bleach) to revitalize the electrodes.



**CAUTION:** NEVER leave the electrode in alcohol for more than 30 minutes at a time. Continuously soaking the electrode in alcohol will weaken the protective coating on the electrode and shorten its life. A damaged electrode showing peeling of the transparent coating will expose tissues to copper. An electrode showing signs of peeling must be replaced.

---

 **CAUTION:** Ammonia is NOT recommended, because silver chloride dissolves in ammonia.

---

## Sterilizing the STX2-PLUS Electrode

The **STX2-PLUS** electrodes are non-sterile as supplied. Acceptable low temperature sterilization methods for the electrodes include gamma irradiation and ethylene oxide gas (ETO).

---

 **CAUTION:** Do NOT autoclave the electrode.

---

---

 **CAUTION:** Do NOT use ionized hydrogen peroxide (H<sub>2</sub>O<sub>2</sub>).

---

---

 **CAUTION:** Do NOT expose the electrodes to ultra-violet light, because UV light decomposes silver/silver chloride electrodes.

---

---

 **CAUTION:** Do not sand or abrade the electrode surfaces. A damaged electrode will expose tissues to copper. An electrode showing deep scratches on the Ag-AgCl surfaces must be replaced.

---

---

 **CAUTION:** Do not immerse the electrode head.

---

## Rechloriding the Electrodes

The **STX2-Plus** electrode must be dipped into chlorine bleach (5% sodium hypochlorite) on occasion to maintain the amount of Ag to AgCl balance. Otherwise, the electrode will become unstable. A 10–15 minute immersion of the tips is recommended before each daily use. (These treatments may be reduced to once per week as experience guides). DMEM deposits cause resistance measurements to become unstable and the coating appears as a dark crust on the electrode surfaces. See “Appendix A: KCL testing mixtures” on page 9. A properly chlorided silver surface will appear to be a dark silvery grey coloration.

<https://www.wpiinc.com/wp-34521-endozime-enzymatic-detergent-169-oz>

<https://www.wpiinc.com/7363-4-enzol-enzymatic-detergent-1-gallon>

---

 **CAUTION:** Too much chloriding can also lead to instabilities. A short 5 minute soak in ammonia water (3%) will convert the AgCl back to Ag. After a DI water rinse, repeat the chloriding. Follow this with an electrode test.

---

## Storing the Electrodes

After a daily use, wash and store the electrodes dry.

## Testing the STX2-PLUS Electrodes

If another electrode is being used, refer to that electrode's manual.

To make sure the electrode is operating properly, a resistance test in KCl is used. This test demonstrates electrode functionality.

|                |                |                |
|----------------|----------------|----------------|
| 40 mM KCl      | 80 mM KCl      | 160 mM KCl     |
| 38-66 $\Omega$ | 27-44 $\Omega$ | 12-20 $\Omega$ |

At the lower molarities (10–20 mM), a DMEM coated electrode will begin to show instabilities at the higher concentrations. If the resistance readings in the KCl mixtures are over 10% out of range, then the electrode may need cleaning. See “Cleaning/ Maintaining the STX2-PLUS Electrodes” on page 5. An Excel scatter plot of the molarity vs. resistance (as a power) should show an  $R^2$  value  $> 0.99x$ .

**NOTE:** These resistance readings can vary due to fluid volume and electrode depth. These values are a reference. An Excel scatter plot of the molarity vs. resistance (as a power) should show an  $R^2$  value  $> 0.99x$ . If the  $R^2$  value is acceptable, then the electrode can be used even if it is slightly out of range. If the resistance readings in the KCl mixtures are out of range, then the electrode may need cleaning. See “Cleaning/ Maintaining the STX2-PLUS Electrodes” on page 5. Electrodes which are not being properly maintained may begin to show instabilities indicating the need for cleaning.

**Regular maintenance of the electrode is strongly recommended for longevity.**

## ACCESSORIES

**99675**  
**7363-4**

EVOM2 Adaptor Cable  
Enzol Enzymatic Detergent



*Fig. 10—Plug the STX2-PLUS into the 99675 cable to use the electrode with an EVOM2. The 99675 cable is sold separately.*

## TROUBLESHOOTING

| Issue  | Possible Cause   | Solution   |
|--|--|--|
| Electrode tips over when released  | The cable is heavy and can cause the electrode to tip over if too much cable is in the air.  | Lay the cable on the tabletop as close to the electrode head as possible.                                      |
| The reading appears to be drifting* (see the drift definition below).    | The electrodes are coated.   | The Electrodes requires enzymatic cleaning.  |
|  | The fluid temperature in the plate is changing.  | Use a plate warmer.  |
|  | In a 5% CO <sub>2</sub> environment, a loss of CO <sub>2</sub> causes the media pH to change, and the resistance reading may increase sharply. | A 5% CO <sub>2</sub> environment can help in reducing pH media changes. A plate warmer can reduce out gassing. |
| The electrode reading is unstable. (see the stability definition below). | The electrodes are coated.   | The electrodes require enzymatic cleaning.   |
|  | The electrodes need to be chlorided.   | The electrodes require chloriding  |
|  | Radio frequency interference   | Turn off or move any cellular phones farther away from the experimental setup.                                 |

**NOTE:** If you have a problem/issue with that falls outside the definitions of this troubleshooting section, contact the WPI Technical Support team at 941.371.1003 or technicalsupport@wpiinc.com.

\* Defining Term:

- Drift–Readings that continuously increase or decreases a significant value (either voltage or resistance) over time. Example 1: At 10 mV the Pd reading is increasing 1 mV/minute. (A drift of 0.1 mV/minute is acceptable.) Example 2: At 1000  $\Omega$  the reading is increasing 100  $\Omega$ /minute. (A drift of 10  $\Omega$ /minute is acceptable.) Excessive drift may be caused by a coated electrode, pH or temperature changes. See “Cleaning/Maintaining the STX2-PLUS Electrodes” on page 5.
- Instability–At 500  $\Omega$ , the reading jumps from 450 to 550  $\Omega$  and will not settle down (an instability  $\pm 5 \Omega$  is acceptable in the 500  $\Omega$  range. In the higher ranges, up to  $\pm 1000 \Omega$  is acceptable at the 100K range. Electrodes showing instability may be coated with DMEM and require enzymatic cleaning. See “Cleaning/Maintaining the STX2-PLUS Electrodes” on page 5.

## APPENDIX A: KCL TESTING MIXTURES

When making a variety concentrations of KCl solution, use the following table as a guide. Start by making a solution of 160 mM concentration. To make 100 mL of 160 mM KCl:

Add 1.192 gm KCl to 100 mL of distilled water. (1M KCl = 74.54 gm/M in 1 L DI water)

| Use                 | Add DIW | Results          |
|---------------------|---------|------------------|
| 50 mL of 160 mM KCl | 50 mL   | 100 mL 80 mM KCl |
| 50 mL of 80 mM KCl  | 50 mL   | 100 mL 40 mM KCl |
| 50 mL of 40 mM KCl  | 50 mL   | 100 mL 20 mM KCl |
| 25 mL of 20 mM KCl  | 25 mL   | 50 mL 10 mM KCl  |

## APPENDIX B: COMPATIBLE INSERTS AND PLATES

| Corning     | Millipore                        | Material  | Membrane Diameter (mm) | Growth Surface Area (cm <sup>2</sup> ) | Membrane Pore Size (µm) |
|-------------|----------------------------------|-----------|------------------------|--|-------------------------|
| <b>3470</b> |                                  |           | 6.5                    | 0.33                                   | 0.4                     |
| <b>3472</b> | <b>PITP01250</b>                 |           | 6.5                    | 0.33                                   | 3.0                     |
| <b>3413</b> | <b>PCF Insert</b>                |           | 6.5                    | 0.33                                   | 0.4                     |
| <b>3415</b> | <b>PITP01250<br/>PCF Insert</b>  |           | 6.5                    | 0.33                                   | 3.0                     |
| <b>3421</b> |                                  |           | 6.5                    | 0.33                                   | 5.0                     |
| <b>3422</b> | <b>PIEP01250<br/>PCF Insert</b>  |           | 6.5                    | 0.33                                   | 8.0                     |
| <b>3495</b> | <b>PIHT12R48*<br/>PET Insert</b> |           | 6.5                    | 0.33                                   | 0.4                     |
|             | <b>PIHA01250</b>                 | HA Insert | 6.5                    | 0.33                                   | 0.45                    |
|             | <b>PICM01250</b>                 | CM Insert | 6.5                    | 0.33                                   | 0.4                     |
| <b>3496</b> | <b>PISP12R48*<br/>PET Insert</b> |           | 6.5                    | 0.33                                   | 3.0                     |
|             | <b>PIRP12R48<br/>PET Insert</b>  |           | 6.5                    | 0.33                                   | 1.0                     |
|             | <b>PIMP12R48*<br/>PET Insert</b> |           | 6.5                    | 0.33                                   | 5.0                     |
|             | <b>PIEP12R48*<br/>PET Insert</b> |           | 6.5                    | 0.33                                   | 8.0                     |
|             | <b>PIXP01250<br/>PCF Insert</b>  |           | 6.5                    | 0.33                                   | 12                      |
|             | <b>PIHP01250</b>                 |           |                        |  | 1.0                     |
|             | <b>PITT01250</b>                 |           |                        |  | 3.0                     |

\* Tri-supports

---

| <b>Millicell</b> | <b>Membrane<br/>Pore Size (µm)</b> | <b>Qty/Pkg</b> |
|------------------|------------------------------------|----------------|
| <b>MCHT24H48</b> | 0.4                                | 48             |
| <b>MCRP24H48</b> | 1.0                                | 48             |
| <b>MCSP24H48</b> | 3.0                                | 48             |
| <b>MCMP24H48</b> | 5.0                                | 48             |
| <b>MCEP24H49</b> | 8.0                                | 48             |

## WARRANTY

WPI (World Precision Instruments) warrants to the original purchaser that this equipment, including its components and parts, shall be free from defects in material and workmanship for a period of 30 days\* from the date of receipt. WPI's obligation under this warranty shall be limited to repair or replacement, at WPI's option, of the equipment or defective components or parts upon receipt thereof f.o.b. WPI, Sarasota, Florida U.S.A. Return of a repaired instrument shall be f.o.b. Sarasota.

The above warranty is contingent upon normal usage and does not cover products which have been modified without WPI's approval or which have been subjected to unusual physical or electrical stress or on which the original identification marks have been removed or altered. The above warranty will not apply if adjustment, repair or parts replacement is required because of accident, neglect, misuse, failure of electric power, air conditioning, humidity control, or causes other than normal and ordinary usage.

To the extent that any of its equipment is furnished by a manufacturer other than WPI, the foregoing warranty shall be applicable only to the extent of the warranty furnished by such other manufacturer. This warranty will not apply to appearance terms, such as knobs, handles, dials or the like.

WPI makes no warranty of any kind, express or implied or statutory, including without limitation any warranties of merchantability and/or fitness for a particular purpose. WPI shall not be liable for any damages, whether direct, indirect, special or consequential arising from a failure of this product to operate in the manner desired by the user. WPI shall not be liable for any damage to data or property that may be caused directly or indirectly by use of this product.

## Claims and Returns

Inspect all shipments upon receipt. Missing cartons or obvious damage to cartons should be noted on the delivery receipt before signing. Concealed loss or damage should be reported at once to the carrier and an inspection requested. All claims for shortage or damage must be made within ten (10) days after receipt of shipment. Claims for lost shipments must be made within thirty (30) days of receipt of invoice or other notification of shipment. Please save damaged or pilfered cartons until claim is settled. In some instances, photographic documentation may be required. Some items are time-sensitive; WPI assumes no extended warranty or any liability for use beyond the date specified on the container

Do not return any goods to us without obtaining prior approval and instructions from our Returns Department. Goods returned (unauthorized) by collect freight may be refused. Goods accepted for restocking will be exchanged or credited to your WPI account. Goods returned which were ordered by customers in error are subject to a 25% restocking charge. Equipment which was built as a special order cannot be returned.

## Repairs

Contact our Customer Service Department for assistance in the repair of apparatus. Do not return goods until instructions have been received. Returned items must be securely packed to prevent further damage in transit. The Customer is responsible for paying shipping expenses, including adequate insurance on all items returned for repairs. Identification of the item(s) by model number, name, as well as complete description of the difficulties experienced should be written on the repair purchase order and on a tag attached to the item.

*\* Electrodes, batteries and other consumable parts are warranted for 30 days only from the date on which the customer receives these items.*

**USA**

175 Sarasota Center Blvd., Sarasota FL 34240-9258  
Tel: 941-371-1003 • Fax: 941-377-5428 • E-mail: sales@wpiinc.com

**UK**

1 Hunting Gate, Hitchin, Hertfordshire SG4 0TJ  
Tel: 44 (0)1462 424700 • Fax: 44 (0)1462 424701 • E-mail: wpiuk@wpi-europe.com

**Germany**

Pfingstweide 16, D-61169 Friedberg (Hessen), Germany  
Tel: +49 (0)6031 67708-0 • Fax: +49 (0)6031 67708-80 • E-mail: wpide@wpi-europe.com

**China & Hong Kong**

WPI Shanghai Trading Co., Ltd.  
Rm 27A, Liangfeng Building, No 8, Dongfang Road, Pudong New District, Shanghai, PR China  
Tel: +86 21 6888 5517 • Toll Free: 400 688 5517 • E-mail: chinasales@china.wpiinc.com

**Brazil**

Av. Conselheiro Nébias, 756 sala 2611, Santos-CEP: 11045-002, São Paulo Brazil Tel: (013) 406-29703 • E-mail: info@brazil.wpiinc.com

**Internet**

www.wpiinc.com • www.wpi-europe.com • www.wpiinc.net • www.wpi brasil.com.br