



# UltraMicroPump III

*UMP3 Microsyringe Injector and Micro4 Controller*

## **INSTRUCTION MANUAL**

Serial No. \_\_\_\_\_

022712

[www.wpiinc.com](http://www.wpiinc.com)

---

# Contents

Introduction .....	1
Parts List .....	2
Set-up and Operation .....	3
Setting Parameters .....	6
UltraMicroPump III Operation .....	13
Defining Other Syringes .....	14
Computer Control .....	18
General Maintenance .....	23
Troubleshooting .....	23
Specifications.....	25
References.....	25
Syringes .....	26
APPENDIX A: Nanoliter 2000/ Micro4 Volume Settings.....	28
APPENDIX B: Micro-stepping .....	29
Declarations of Conformity.....	33

Copyright © 2012 by World Precision Instruments, Inc. All rights reserved. No part of this publication may be reproduced or translated into any language, in any form, without prior written permission of World Precision Instruments, Inc.

## Introduction

WPI's **UltraMicroPump III (UMP3)** uses microsyringes to dispense nanoliter sample volumes. Microsyringes are easily installed by placing the syringe barrel into the UltraMicroPump's clamps. UltraMicroPump accepts syringes from 0.5  $\mu\text{L}$  to 250  $\mu\text{L}$ .

With its microprocessor controller, **Micro4™ (UMC4)**, this versatile injector can be useful for a wide range of applications including intracellular injection, micro delivery of biochemical agents or dyes, cell separation, *in vitro* fertilization, and can be mounted directly onto a stereotaxic frame or micromanipulator.

Operating parameters for the UltraMicroPump are set with the Micro4. Up to four pumps may be independently controlled. Operating parameters set by the user are stored in "non-volatile" memory for instant recall when the unit is powered on.

An optional footswitch can be plugged into an RS232 port on the rear of the controller for "hands free" start/stop operation. The same port may also be used to connect the controller to a computer or to some other device for TTL triggering.

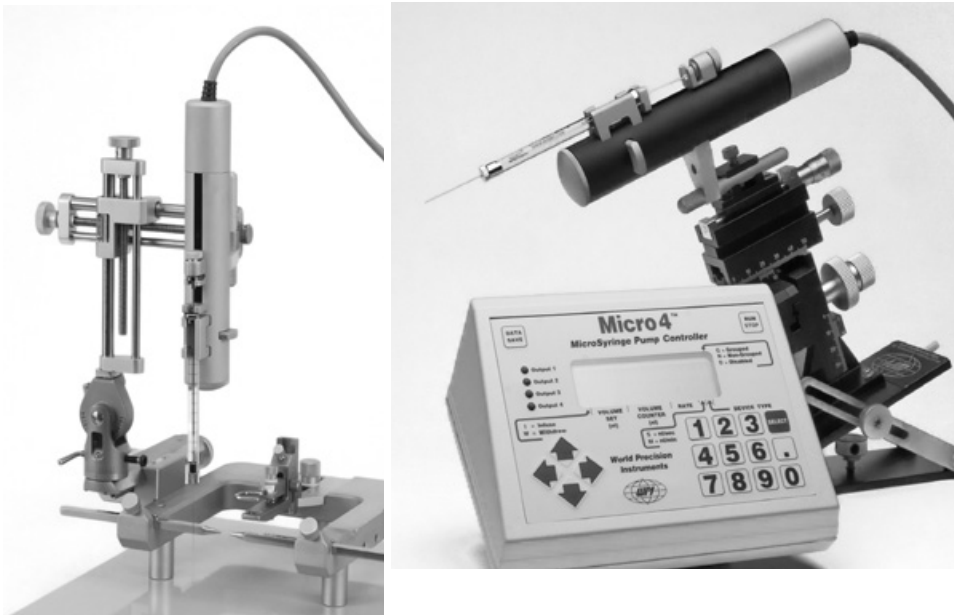

**Fig. 1 – UltraMicroPump III and Micro4 controller.** The pump above is mounted on WPI's M3301 micromanipulator and TB-1 stand (not included); and syringe with luer  $\mu\text{Tip}$  (not included). At left, pump is shown with TAXIC900 stereotaxic frame (not included).

# Parts List

After unpacking, make certain that there is no visible damage to the instrument. Check to see that all items are included:

- UMP3** UltraMicroPump III
- UMC4** Micro4™ Controller, 4-Channel
- 40300** 12-volt Power Supply
- 503546** Phillips screwdriver #0
- Power Cable
- Allen key
- Instruction Manual

For a list of microsyringes available from WPI, see page 26.

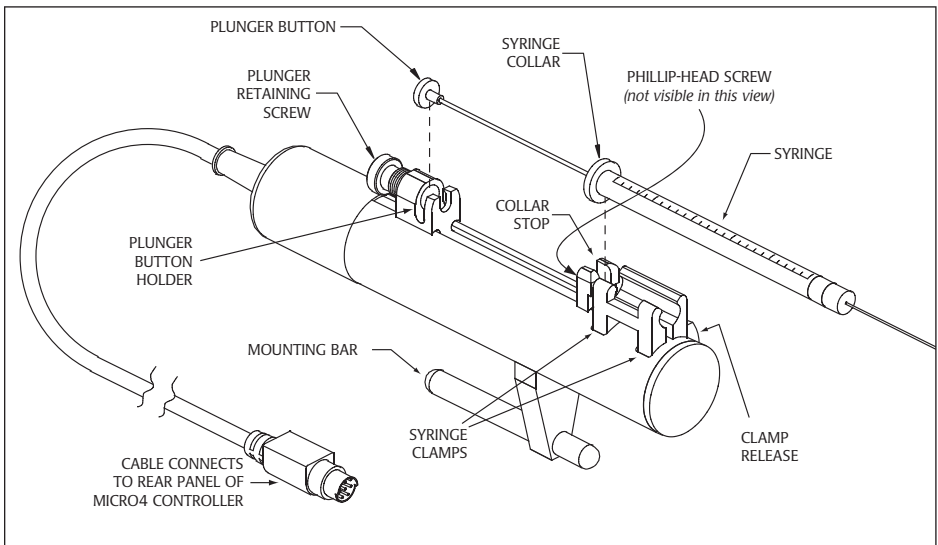

**Fig. 2 (above)**— Check the collar stop to verify that the syringe is held firmly. Adjust as required for ease of removal without damage to glass syringes. Press in the clamp release to open the syringe clamps, release to hold the syringe. The plunger retaining screw should only be "finger-tight."

**Fig. 3 (right)**— UMP III collar stop adjustment screw

# Set-up and Operation

These instructions will help you put the UltraMicroPump to immediate use. We recommend that you read the entire manual and familiarize yourself with the various operating procedures of the UltraMicroPump and Micro4.

## Mounting the syringe

Syringes may be filled manually before mounting in the UltraMicroPump or filled by using the fast reverse function (see page 13). Place the plunger button of the filled syringe into the plunger button holder (leaving the plunger retaining screw loose) while also placing the syringe collar into the collar stop (see Fig. 2). Take care not to damage the syringe collar during this installation. Gently tighten the plunger retaining screw so that the plunger button is secure when the pump is activated (this allows for zero volume error during pump operation).

## Axial Needle Alignment

In order to maintain a good syringe needle alignment particularly along the same axis of the supporting bar, rotate the syringe body while placing in the two clamps to allow the syringe to seat properly and align along the body of the pump for minimal slant offset. If the clamp which holds the syringe collar (see “collar stop” in the drawing below) is too tight or too loose, syringe needle alignment may be off because of stress.

## Collar Stop Adjustment

If the collar stop is too tight to allow the syringe collar to insert easily, it can be adjusted. A small, Phillips-head adjustment screw attached to the collar stop is located immediately below and behind the collar stop, in the groove with the long drive screw. (See Fig. 3.) With the #0 Phillips screwdriver (WPI #503546), loosen this screw slightly (about 0.5 to 1 mm) to allow for a thicker collar. If necessary, grasp the collar stop and wiggle it backwards to move it. Once the stop is backed out, adjust for a tight fit so the syringe body does not move when placed into the holder. Gently re-tighten the screw in the new position.



**Note:** The plunger button holder may need to be retracted to access the set-screw.

## Mount the pump

The UltraMicroPump can be mounted directly onto a stereotaxic frame or a micromanipulator, using the mounting bar (see Fig. 2). The mounting bar may be unscrewed and repositioned by the user, if necessary.

## Mounting to Stereotaxic Frames

WPI's UMP3 fits directly into most standard stereotaxic frames. The UMP3 mounting bar diameter is 7.90 mm (0.311 in.). For example, UMP3 fits directly into Kopf Standard 900 series frames (in place of 1770 electrode holder).

## Connect the controller

Plug the UltraMicroPump cable into an output socket on the back of the Micro4 controller (see Fig. 3). Up to four pumps may be connected and independently controlled.

## Plug in the 12-volt power supply and power up

Plug the 12-volt power supply into the rear panel of the Micro4 (see Fig. 4). The switchable power supply included with this unit automatically senses input line voltage between 100 and 240 V and converts it to 12 V. Connect the power cord to the power supply and plug it into an electrical outlet. The power switch is also located on the rear panel of the Micro4.

Switch the Micro4 on and check that the LCD screen is illuminated.

**Fig. 4 —** Micro4 rear panel

**Plug in the 12-volt power supply.**

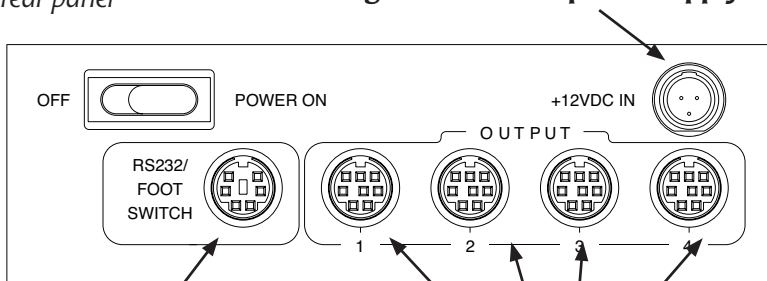

**Footswitch or RS232 cable from computer plugs into this port.**

**Connect up to four UltraMicroPumps.**

The hardware setup is now complete. Before operating the UltraMicroPump you must enter the parameters into the Micro4 controller.

## Choosing a Syringe

The syringe should be chosen to inject no less than 5% of the volume of any given syringe.

**Example:** A 100  $\mu\text{L}$  syringe may be used for injections on the UMP3 to volumes of 5  $\mu\text{L}$  (5000 nL) and higher with high precision and repeatability. Expecting this 100  $\mu\text{L}$  syringe to inject lower than 1  $\mu\text{L}$  may be difficult if the syringe is not calibrated specifically on the pump. The overall accuracy of the syringe itself is usually no greater than  $\pm 3\%$  and the syringe internal diameter may deviate from location to location along the length of the syringe interior.

Choosing the correct syringe for an injection is a very important consideration, due to accumulated errors of the syringe and the pumping method. For a 1000 nL injection from a 10  $\mu\text{L}$  (10,000 nL) syringe, the user is asking for a 1/10th the syringe's volume value to be injected. Theoretically, based on mathematics without any consideration to surface tension, heat, pressure, compressibility, silanization, or air bubbles, the 3% error rate should yield a  $\pm 300$  nL variance.

As a rule of thumb, the choice of the syringe should not exceed 1/10th to 1/20th the stated full volume of the syringe. The Micro4-UMP3 system uses a stepper motor to move the syringe piston forward to inject the volume. A consideration should also be made to allow the motor to step forward a good number of steps to prevent errors in volume injecting.

**Example:** In the 10  $\mu\text{L}$  case above, a 1-step movement of the motor will inject a volume of 0.5276 nL. For two steps to occur, a volume of 1.055 nL will be injected. This may or may not be acceptable as the total error may exceed 1 nL or nearly 0.1%. Also note that two steps is probably not enough resolution to accurately control the volume; another rule of thumb would be to step no less than 10-100 steps for the entire single injection. Using this 10-step rule, the minimum acceptable injectable volume from this 10  $\mu\text{L}$  (10,000 nL) syringe would be  $0.5276 \text{ nL} \times 10$  or 5.276 nL. Other syringes will give other results, due to the inside diameter and the volume per step.

# Setting Parameters

Parameters are entered using the membrane keys on the front panel of the Micro4. The **LEFT** and **RIGHT ARROW** keys move the cursor on the LCD display to the desired position. The **UP** and **DOWN ARROW** keys select the channel (corresponding to the output channels on the rear of the instrument). The **NUMBER** keys and the **SELECT** key are used to change parameters.

## Setting Infuse/Withdraw

**Fig. 5 —** Micro4 front panel

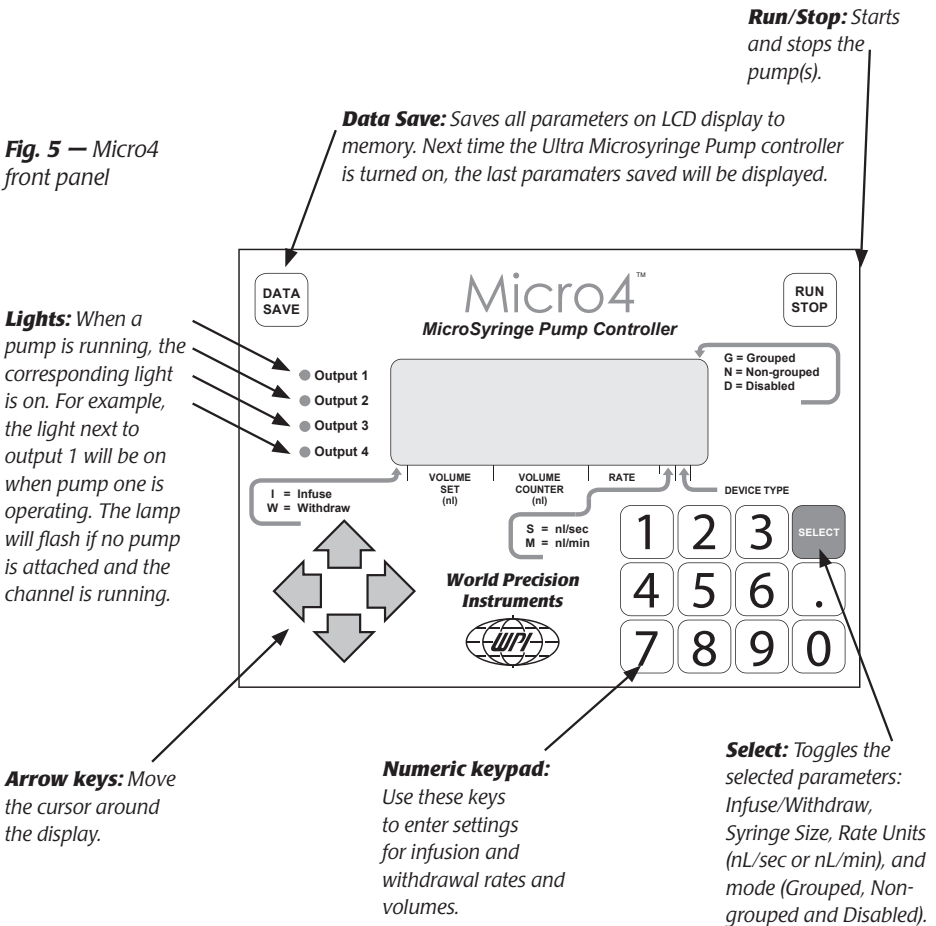

The character displayed in the first field indicates the operating mode — **I** for Infuse, **W** for Withdraw. To change modes, use the **ARROW KEYS** to position the cursor in this field, then press **SELECT**.

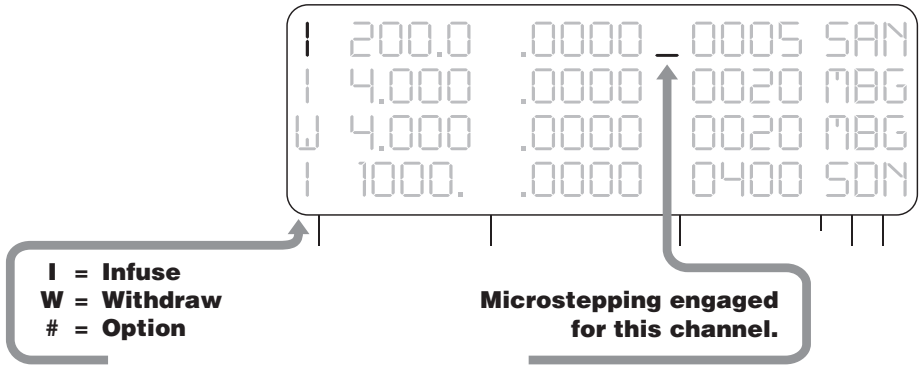

In addition, options 1 through 5 below may be enabled or disabled when the cursor is in any Infuse/Withdraw field: position the cursor in any Infuse/Withdraw field and press the corresponding option number.

- 1** Disables audible tone.
- 2** Enables audible tone (default).
- 3** Changes the action of **RUN/STOP** key or footswitch. When this option is enabled the pump will operate as long as the **RUN/STOP** key or footswitch is pressed and stop when the **RUN/STOP** key or footswitch is released.
- 4** Returns **RUN/STOP** key or footswitch to normal operation (default).
- 5** Sets Volume per Step for syringe types not already preset in the Micro4's memory (see page 14).
- 6** Microstepping on: Locate the cursor at the leftmost position for the channel to activate this option on and press the "6" key.
- 7** Microstepping off: Locate the cursor at the leftmost position for the channel to activate this option on and press the "7" key (default).

For a definition of the microstepping function please see Appendix B. These conditions are saved in permanent memory by the save key.

All of the above selections are global for functions 1 through 4. Functions 5, 6 and 7 are channel specific. The parameters for these functions may be changed while the pump is running.

---

## Volume Set

To select the desired volume to be infused or withdrawn, position the cursor in the volume set field and enter the numbers with the numeric keypad. The values shown on the LCD display are in nanoliters. (Note: For 10  $\mu\text{L}$  enter "10000"; for 1.0  $\mu\text{L}$  enter "1000."—including decimal point.)

**Syringe Injection Accuracy:** Since every syringe in the microliter volume range has its own unique intricacies, you should verify and calibrate each syringe and log its characteristics for accurate injections. The Micro4 controller has preset *types* of syringes to very accurately move the plunger button of the syringe a precise distance per injection.

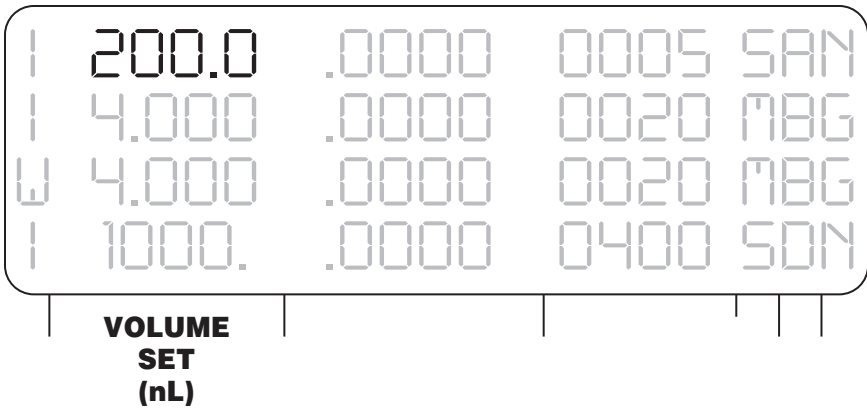

## Volume Counter

Real-time display of volume being delivered. When pump is not running, this number may be changed; when pump is restarted, counter will continue from the number entered.

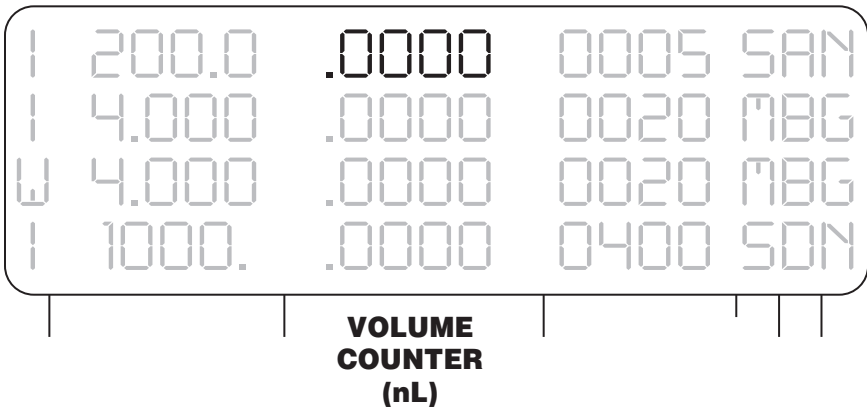

## Injections beyond 99,999 nL (5 digits in the volume field)

Example: You want to inject 150,000 nL from a 500  $\mu$ L liquid tight syringe, but the volume counter can not accept 150,000 as a number.

1. Take the value  $150000 / 500000 = 0.3$  or 30% of the syringe volume.
2. Use a syringe TYPE that can accommodate a proportionally reduced number of the same injection percentage (in this case 50%).
3. Using TYPE H, a 250  $\mu$ L syringe as the choice a 75,000 nL injection is equivalent to a 150,000 nL injection in a 500  $\mu$ L syringe.
4. Multiply times 60 mm for the actual distance travel  $0.3 \times 60 = 18$  mm (60 mm is the full volume stroke of the syringe).
5. Check:  $75,000 / 250,000 = 0.3$ ;  $0.3 \times 60$  mm = 18 mm.
6. Any combination of syringe types and volume choices can be used to displace a particular length, as long as the volume is noted and the injection speed does not exceed the rated value nearest that syringe volume. See syringe tables, page 11.

## Rate setting / unit time

To select the rate for infusion or withdrawal, position the cursor in this field and type in the desired value with the numeric keypad. If the rate entered is too large for the selected syringe type, the highest possible value will be displayed in this field. Next, select the rate units.

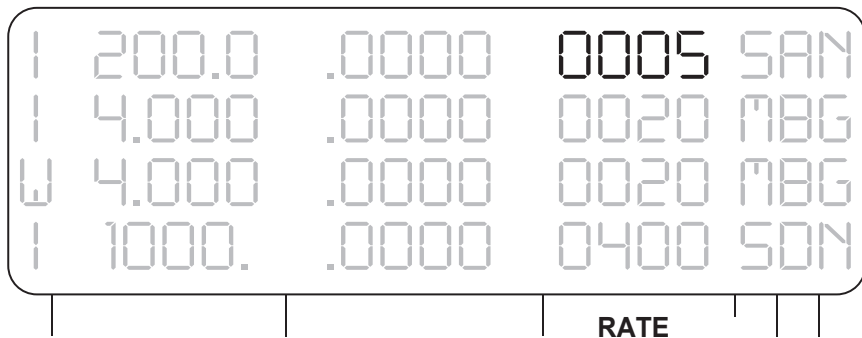

---

## Rate Units

Two rate units are available — nanoliters per second and nanoliters per minute. Position the cursor in this field and use the **SELECT** key to choose either **S** (nL/sec) or **M** (nL/min).

I	200.0	.0000	0005	SAN
I	4.000	.0000	0020	M8G
W	4.000	.0000	0020	M8G
I	1000.	.0000	0400	SDN

**S = nl/sec**  
**M = nl/min**

I	200.0	.0000	0005	SAN
I	4.000	.0000	0020	M8G
W	4.000	.0000	0020	M8G
I	1000.	.0000	0400	SDN

**DEVICE TYPE**

## Device (syringe) Type

The volume per step and rate data for eleven microsyringes are already stored in Micro4's memory. To specify one of these syringes, position the cursor in this field and use the **SELECT** key to change the syringe type to a letter (**A - P**) corresponding to that of the syringe in the table below.

Type	Syringe Volume	Scale Length	ID (mm)	nL / step REV K	Max. Rate nL /sec	Max. Rate Microstep Mode nL /sec
A	0.5 µL	54.1 mm	0.1085	0.0294	20	1
B	1.0 µL	54.1 mm	0.1534	0.0587	40	2
C**	5 µL	54.1 mm	0.343	0.2934	202	14
D	10 µL	54.1 mm	0.485	0.5868	451	29
E	25 µL	60 mm	0.73	1.329	1022	66
F	50 µL	60 mm	1.03	2.646	2035	132
G	100 µL	60 mm	1.46	5.315	4088	265
H	250 µL*	60 mm	2.3	13.191	9999	659
I	500 µL*	60 mm	3.26	26.501	9999	1325
J	1000 µL*		4.61	52.995	9999	2649
K	Nanoliter 2000 †		0.48 plunger in 0.50 glass	2.3 nL /step (0.0005" step)	884	115
L	10 µL	60 mm	0.4607	0.5293	407	29
M,N,O,P	User Defined			See page 14	custom rate ‡	
**	ILS005		0.4856	0.5880 compensates for length as TYPE M		

\* Gas-tight syringes are not recommended for UMP3 in these volumes; instead, use a liquid-tight syringe to prevent drive motor damage or stalling.

\*\* The ILS005 5 µL syringe must use type M, N, O or P with a 0.5880 nL/step entry. See page 14 for details.

† WPI's **Nanoliter 2000**, a nanoliter injector for the 2-70 nL range, comes with its own simple controller but may also be driven by the Micro4. For more information, enquire about WPI # **B203XVY**.

‡ The custom syringe rate maximum is calculated internally and is determined by the nL/step value times 10000 and divided by 13. The microstepping maximum rate is nL/step \*10000 / 200.

### Note On Syringe Stroke Length

Maker	Syringe	Stroke Length	Use TYPE
Hamilton	1700 Series, 10µL	60 mm	L
Hamilton	700 Series 5 µL , 10 µL	54.1 mm	C,D
Hamilton	7000 Series	60 mm	M,N,O,P*
SGE	0.5 µL – 10 µL	54.1 mm	A,B,C,D
ILS 5 µL Luer tip	ILS005	28 mm	M,N,O,P
SGE, Hamilton 700, Hamilton1700	25 µL – 500 µL	60 mm	E - L
WPI	FlexiFil™	54.1 mm	D
WPI	NanoFil™	60 mm	L

The delivery of the UMP3 is based on 60 mm or 54.1 mm syringes. Please note which syringe length you are using as a factor of 0.9016 may need to be applied to the volume to be injected in order to have a precise injection. For the ILS005, use the TYPE "M" values in the above table.

*Not all syringes from a particular series or manufacturer are usable on the UMP3. See table on page 15.*

---

## Grouped/Non-grouped/Disabled

For convenience in operating multiple pumps (whether of identical or various volumes), pumps may be grouped or non-grouped. Pressing the **SELECT** key while the cursor is in this field will toggle through three operating modes:

**Grouped mode:** Syringe channels with “G” in this field are started or stopped when the **RUN/STOP** key is pressed while the cursor is located on any grouped channel.

**Non-grouped mode:** When the cursor is positioned on a channel that is not grouped, indicated by the letter “N”, only that channel will start or stop when the **RUN/STOP** key is pressed.

**Disabled mode:** When a channel is disabled, the line of data is hidden and the pump will not operate. No changes may be made to this channel while it is disabled. To re-enable it, move the cursor back to the Group/Nongroup field and press the **SELECT** key; the previously entered data will be restored.





## Saving your settings

Pressing the **DATA SAVE** button will store these values into the controller's memory for future use.



# UltraMicroPump III Operation

When the pump runs, a series of beeps indicates that the pump is running. A lamp on the back of the UltraMicroPump indicates a signal from the controller. As the pump runs, the counter increments as an indication of the plunger's motion. Multiple injections can be achieved by pressing the **RUN/STOP** button again after the pump has stopped.

## Fast forward

  Press and hold the **RIGHT ARROW** key then press **RUN/STOP**. The syringe pump will continue running as long as these two keys are depressed.

## Fast reverse

  Press and hold the **LEFT ARROW** key then press **RUN/STOP**. The syringe pump will continue running as long as these two keys are depressed.

## Example

Check the fit and seating of the syringe on the pump head (see page 3 for the collar fit). Program the syringe TYPE into the Micro4 controller (see page 11).

Place a partially prefilled syringe on the pump and move the plunger button holder (by use of the fast forward and fast reverse as necessary to align and capture the syringe plunger without withdrawing any air into the needle tip. Center the syringe plunger and tighten the carrier screw.

Expel some fluid to insure no air is in the syringe needle. Infuse the fluid to the required amount for the injection or for multiple injections, be careful not to over run the maximum volume of the syringe or inject more than the total syringe filled volume.

Program the volume into the controller (always in nanoliters). Test the injection or prime the carrier play (see note below). Apply the injection(s).

**NOTE:** The plunger carrier has a mechanical play of up to 100  $\mu\text{m}$  in each direction. This play corresponds to about 32 steps (100  $\mu\text{m}$ / 3.175  $\mu\text{m}/\text{step}$ ) of the motor and this should be taken into account when changing pump directions. This also corresponds to 18.48 nL on a 10  $\mu\text{L}$  syringe (34.49 steps/ 0.5868 nL/ step). The user should also "take up" this play by moving the carrier a like distance to insure that the volume is moved. See page 11 for details on each syringe's volume per step value.

# Defining Other Syringes

Eleven microsyringes with volumes ranging from 0.5 µL to 1000 µL are already preset in the Micro4 (syringe types **A** through **L** — see table on page 11). A microsyringe with a volume other than those preset may be entered as device type **M**, **N**, **O** or **P**; however, the Volume per Step must be user-defined.

You may program the M, N, O and P custom syringes in any channel location (1, 2, 3, 4). The custom memory designator (M,N,O,P) must be entered in the TYPE column to program the memory. The “5” key that writes nL/step value to the memory needs to be pressed in that channel’s I/W position. Custom defined syringes M, N, O, and P may be used in any channel position or multiple channels. The factory default values for these memory points are the TYPE “D” syringe (0.5868 nL/sec).

## Procedure

First, calculate the Volume per Step using the formula below. Syringe displacement is the distance between 0 and the maximum volume marked on the syringe in inches. Syringe volume is in nanoliters. ID is in millimeters.

### Syringe of known ID

$$\text{Volume per Step} = (\text{ID}/2) \times (\text{ID}/2) \times 3.1415926 \times 1000 \times 0.003175$$

### Syringe of unknown ID

The Inside Diameter (ID) of a syringe can be determined by this formula: *from your own measurements.*

$$\text{ID} = \text{SQRT}(\text{Volume}/(3.14159 \times \text{Length})) \times 2$$

where length is the visible marking on the syringe body (total length in mm) and Volume is the full volume of the syringe in microliters.

For example, if you have a 60 mm syringe with a 2.5 µL volume, use the formula above to determine its Volume per Step. Move the cursor to the Volume Set field for the desired channel and enter the calculated value (in this case, 0.1329 nL):

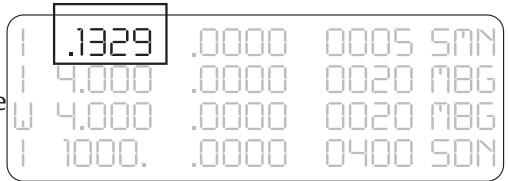

Then use the left arrow key to scroll the cursor to the first position on the LCD display and press **5**. This sets your calculated definition for your type M syringe into the Micro4’s memory.

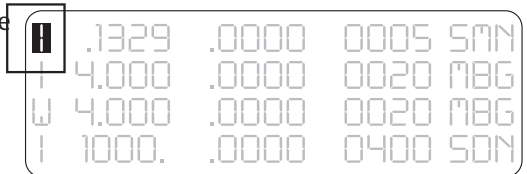

Before proceeding, move the cursor back to the Volume Set field and re-enter the correct volume for the syringe on output channel 1 (which may be any type — not necessarily type M, N, O or P).

## Special Syringe Considerations ILS005

The UMP3-Micro4 was designed around 60 mm or 54.1 mm syringes. The full injection of a 5  $\mu$ L syringe is expected to be a 60 mm movement. In the case of this ILS special 5  $\mu$ L glass luer tip syringe this length is 27 mm for an injection of 5  $\mu$ L.

There are two solutions:

**Solution 1.** Using Type "C" (the 54.1 mm 5  $\mu$ L syringe), Multiply the volume to be injected by 27/54.1 or (0.4990). Example. A 2500 nL injection using type C should be entered into the micro4 as  $2500 \times 0.4990$  or 1247.5 nL. this value can be further calibrated see page 17 for details.

**Solution 2.** Using Type M, divide the Type C nL/step number by 0.4990. Example: The standard 54.1 mm syringe has a value of 0.2934 nL/step on a 5  $\mu$ L syringe. The ILS005 has a 27mm stroke for this same full volume.  $0.2934 / 0.4990 = 0.5880$  is the nL / step value to enter following the Type M instructions on this page. (0.5880 is also verified by the formulas on the previous page.)

After defining your syringe in Micro4's memory, move the cursor to the Device Type field of the output channel to which that pump is connected and press **SELECT** until **M** appears.

I	200.0	.0000	0005	SAN
I	4.000	.0000	0020	M
W	4.000	.0000	0020	M8G
I	1000.	.0000	0400	SON

Any number of channels may use type **M** syringes, but since a single definition for type **M** is stored in Micro4 all **M** devices must be identical. (That is, you cannot use two non-standard types, such as 2.5  $\mu$ L and 0.25  $\mu$ L.)

The minimum delivered volume depends on the syringe size and is listed in the syringe type table under Volume per Step. The actual volume delivered is divisible by the volume per step. For example, using a syringe with a Volume per Step of 1 nL, actual delivered volume for the given set volume is listed below.

Volume Set	Actual volume delivered
0-0.9999 nL	0
1 nL-1.999 nL	1 nL
2 nL-2.999 nL	2 nL

## Hamilton 7000 Series

Volume ( $\mu$ L)	ID (mm)	nL/Step	TYPE
0.5	0.1030	0.0265	User defined
1.0	0.1457	0.0529	User defined
2.0	0.2060	0.1058	User defined
5.0	0.3257	0.2645	User defined

---

## Using Teflon Tipped syringes

Carefully remove the plunger and its Teflon tip by drawing it out of the syringe barrel.

1. Before inserting the plunger tip into the syringe, pre-wet the Teflon plunger tip and the syringe body interior with water.
2. Use care in inserting the plunger into the syringe as the plunger rod may be easily bent.
3. Carefully place the plunger tip into the syringe and gently work the tip down into the body of the syringe using a thumb and forefinger to grasp and push small lengths of the plunger rod into the syringe. Repeat this procedure until the plunger tip is near the zero mark of the syringe.
4. Draw additional water into the syringe and slowly work the plunger up and down until the plunger tip is cold formed into the syringe and the stiffness goes away. The stiffness of the new plunger tip may require you to move the rod in small increments until the tip is formed enough to actuate by the rods full length.

## Wet Autoclaving Syringes

Typically the answer to autoclaving any Teflon syringe is no, since the adhesives and the Teflon seal will eventually breakdown or swell from the heat and pressures involved. The most practical method of sterilizing is either gas or liquid chemical sterilization, but both require meticulous removal of the sterilizing agents prior to use.

If you are willing to replace the syringe after a few uses then most syringes will stand up to a few cycles of wet autoclaving. The Teflon tipped plunger should be removed for this operation. Careful examination of any glued components and the Teflon tip integrity is required before reuse of an autoclaved syringe. If the Teflon tip cannot be replaced into the syringe body easily then the plunger (tip) and perhaps the syringe requires replacement due to infusion of water. Autoclaving will usually void the warranty on Teflon tipped syringes.

## Calibration

***Every syringe should be calibrated on the pump that it is being used with.*** This gives the user two things, verification of the error involved in the injection and the confidence that injection is correct. Micro volume syringes are rated at 1% to 3% of the full-scale volume. So for a 10  $\mu\text{L}$  syringe injecting 10  $\mu\text{L}$  there will be a maximum error of  $\pm 0.3 \mu\text{L}$  if the injection takes place along the markings on the syringe barrel. When used in a specialized syringe pump like the UMP3, this same syringe is now defined by a fixed length and moved by a precision stepper motor. This can offer a very high degree of precision and repeatability. This same 3% error 10  $\mu\text{L}$  syringe can now be calibrated to deliver a reduced error of  $\pm 0.5\%$  tolerance or better.

## Two methods of calibration

### *Volumetric diameter measurement*

Using a microscope and a calibrated reticle or stage micrometer, inject an amount of water into a hydrated oil droplet, measure the sphere and use

$$\text{Volume} = ((\text{Diam}/2) \times (\text{Diam}/2) \times (\text{Diam}/2) \times 3.1415926 \times (4/3) \times 1000)$$

to determine the volume in nanoliters. (Diameter in mm.)

### *Analytical Balance*

Use an analytical balance to weigh the mass of the injected volume. (Pure water is 1 gm = 1 mL at 4 degrees C.) Tables for other temperatures are easily obtained.

### *Calibration on the Pump*

Method 1: Multiply the ratio of the injected volume by the actual volume and adjust the volume injected accordingly.

Method 2 : Use the TYPE M syringe and enter the new nl/sec number after recalculation.

**Note:** It may be necessary with some syringes to verify injections at different locations along the length of the syringe barrel as there can be variations along the inside length of the glass barrel.

*Calculate in Microsoft Excel — just enter these formulae into a spreadsheet, replacing Volume, Length, and ID from your own measurements.*

---

# Computer Control

RS232 commands are used to control the Micro4 via the serial port of a PC or Macintosh computer.

## RS232 Commands

All commands are case sensitive. The settings for the RS232 port are baud rate 9600, 8 data bits, 1 start bit, 1 stop bit. Microsoft HyperTerminal setting: Flow control must be set to NONE. Turn off echo characters locally and Append line feeds. Set character delay to 50 ms under ASCII setup.

Numbers and decimal points are indicated below by the “#” symbol.

- V#####;** Sets the delivered volume. Number must have a decimal point and terminate with “;” (semicolon) — see page 19.
- C#####;** Sets the volume counter. Number must have a decimal point and terminate with “;” (semicolon) — see page 19.
- R#####;** Sets the delivery rate. Number must have a decimal point and terminate with “;” (semicolon) — see page 19.
  - I** Infuse mode.
  - W** Withdraw mode.
  - G** Go — Starts the syringe pump.
  - H** Halt — Stops the syringe pump.
  - S** Sets the rate units to nanoliters/second.
  - M** Sets the rate units to nanoliters/minute.
  - L#;** Line number — sets the syringe number on display (Micro4 only).
  - N** Not Grouped mode.
  - P** Grouped mode.
  - D** Disabled mode. (The line goes blank.)
  - Tx** Syringe Type. The letter indicating syringe type follows the T. For example, to select syringe type “A” the command is “TA”.

## RS232 Query Commands

All query commands begin with a question mark. Below is a list of the query commands.

- ?V** Returns the set volume.
- ?C** Returns the volume counter
- ?R** Returns the delivery rate
- ?X** Returns the maximum syringe rate
- ?P** Returns the step rate (nL/step)

**?T** = number of steps taken

**Note:** the nL/step cannot be programmed remotel.

**?1** or **?2** returns T for true if the beeper is enabled.

**?3** or **?4** returns T for true if the press once to RUN the total volume is true.

**?6** or **?7** returns T for true if microstepping is enabled.

**?M** Returns a G for grouped mode, N for nongrouped mode, and D for disabled mode.

**?S** Returns the letter of the syringe type.

**?D** Returns the syringe pump direction: I=infuse, W=Withdraw.

**?U** Returns the rate units: S=nL/second, M=nL/minute.

**?G** Returns **R** if pump is running, **S** if pump is stopped.

As a reminder, many of the above commands are listed on the Help screen which appears when **??** is entered at the prompt in the HyperTerminal window.

```

Micro-4 Communication - HyperTerminal
File Edit View Call Transfer Help
??
|
??
Set line number: L1...L4
Query pump status: ?G returns R if running, S if stopped
Change pump status: G starts pump, and H halts pump
1/2 turns beep On/Off. ?1 and ?2 return T/F if On/Off.
3/4 sets run to Hold/Toggle. ?3 and ?4 return H/T if Hold/Toggle.
6/7 turns microstepping On/Off. ?6 and ?7 return T/F if On/Off
?P returns step size (nL/step) and ?X returns max rate (nL/sec).

In the following table, the first line shows the parameters as they
appear on the LCD screen. "Query" commands return parameter values.
Commands on the last line are used to change parameter values.

      I/W  1.234   1.234   1234   S/M  A...P   N/G/" "
Query  ?D  ?V     ?C     ?R     ?U  ?S     ?M (=N/G/D)
Change I/W  V1.234; C1.234; R1234; S/M  TA...TP  N/P/D

Set File/Properties/Settings/ASCII setup/Character Delay = 50 milliseconds
if you want to paste multiple commands into HyperTerminal.

-

```

Connected 0:00:49    ANSIW    9600 B-N-1    SCROLL    CAPS    NUM    Capture    Print echo

---

## TROUBLESHOOTING RS232 Commands

### **The correct format in relation with a specific command sent is as follows:**

There is no set sequence to follow when issuing commands, but for logical programming purposes, follow the following sequence: L1;IV100.0;C0.0;R200.0;STFN

Note there are no spaces, line feeds or enters (carriage returns). The CR does not interfere.

The V, R and C parameters require a "." (decimal point) and the character ";" (semi-colon) to be entered.

You should immediately see a response on the UMC4 display from each entry as it is entered.

The cursor channel indicator (the L#; command) must be on the pump channel that is being run. If the cursor is elsewhere, then the command will not function on other channels unless the grouping is turned on (G last column).

### **Format of the V volume command**

The character field of V is a maximum of five numerals; a 6th character can be the period (.). There is no requirement for a zero to the right of the decimal point. One could enter **V12345.;** and see the result echo by typing **?V** and getting 12345 on the display. The channel selected will show 12345 on the UMC4 display as soon as the ";" character is typed.

### **Format of the R rate command**

The character field of R is a maximum of four numerals; a 5th character can be the decimal point (.). You cannot override the maximum number for the syringe type. Example: Type A is a 0.5 µL syringe and has a maximum rate of 20 nL/sec. Typing in a greater number will still give you the maximum rate of 20 nL/sec.

### **Format of the C counter command**

The character field of C is a maximum of five numerals; a 6th character can be the decimal point (.).

This field should be entered as C0.0; to begin with as this is the counter that determines how much more the syringe needs to move before it stops. Note: Resetting this field to 0; may be required in certain conditions.

The Micro4 Controller echos the following if issued the preceeding command

V123.4; will give 123.40

V12.34; will give 12.340

V12.; will give 12.000

C1234; = 12340

C1234.; = 1234.0

R100.0; = 0020. (TYPE A rate restriction)

R1000.; = 1000. (Using type F, 2035 maximum rate)

R1000.1; = 1000.

V120; will yield 12000. since the decimal point was not entered.

### Display not showing programmed values

If the volume and the rate cannot immediately be seen on the Micro4 display, this could be due to the Grouping being turned off; the programmed units display comes up immediately on acceptance of the ";" transmission.

The first item to test is the line number command and see that the cursor moves to the line and blinks.

When the final character ";" is entered then the display will change, if it does not, then apply a hard reset. (Power off then on and try again). All the parameters need to be entered for the pump to act accordingly; blank fields are unknowns (most likely a previously stored condition).

### Non-grouped Dispensing

The pump channel where cursor is blinking is the only active program line that will activate. The way to run multiple lines is to run them grouped or run them by separate commands after the line number is changed to that channel. The channels in this latter case are completely independent from each other (non-grouped).

### Incorrect Volume Dispensed

The amount of volume actually dispensed was what was programmed in on a prior programmed instance. To correct this, reset the counter, specify the C parameter as "C0.0;" with the Volume and Rate on a separate command line, just before issuing the G (go) command.

## RS232 Cable Pinouts

To control the Micro4 by computer, the RS232 cable must be configured as shown here:

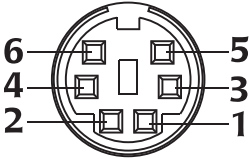

**Mini-DIN connector  
on rear panel of  
Micro4 controller**

Micro4 cable with  
9-pin connector is WPI  
#40500.

Signal	Micro4 Mini-DIN	9-Pin D-sub	25-Pin D-sub
Ground	5	5	7
UMC Data IN	3	3	2
UMC Data OUT	4	2	3
Run/ Stop	6	-	-
+5V pull up	2	-	-

## Footswitch Connections

Since the footswitch produces Run and Stop signals by connecting +5 volts (from pin 2) to pin 6, this port may also be used for TTL signals from other sources. The TTL pulse duration requires 50 ms minimum.

## General Maintenance

UltraMicroPump requires minimal maintenance; regular laboratory cleaning will keep this instrument in optimum operating condition.

Do not apply solvents or oils to any part of the UltraMicroPump.

This instrument is **not autoclavable**.

Do not disassemble—there are no serviceable parts inside either the UMP3 or the Micro 4 controller.

Always hold UltraMicroPump by the main body or mounting bar. Do not swing or carry the UltraMicroPump by its cable.

### Storage:

Store the UMP3 in a sealed plastic zip bag to prevent dust from accumulating on the drive screw. Excessive dust can cause jams and inadvertent stops.

Use of gas-tight syringes on the UMP3 is not recommended for syringes above 250  $\mu\text{L}$  as this can damage the motor. Please use liquid-tight syringes for applications that require volumes greater than 250  $\mu\text{L}$ .

## Troubleshooting

*Problem:* The instrument motor makes noise but the plunger button does not travel.

*Check:* Look for a loose connector at the rear of the Micro4, make sure the UMP3 plug is firmly seated. The gray plastic plug should be a flush fit with the connector on the controller. Verify that the pins in the connector are not damaged.

*Check:* Test the pump in another channel, with the same program parameters.

### Instrument Overtravel

If the plunger button has traveled to the extreme edge of the pump and has jammed, try the following procedure to free the plunger button:

Place the pump so that the syringe would be pointing to the right (no syringe should be in the pump). Program the Micro4 to Syringe style F (or larger to H), program in about 2000 to 5000 nL in the volume and program in a rate of 2000 or greater (there are internal limits). Press and hold the Right or left arrow key for the direction you want the plunger holder to move in and quickly tap the RUN/STOP key a couple of times to unwind the tension on the drive screw and move the plunger holder away from the end of its travel. Lastly, apply a slight pressure on the plunger carrier in the direction the pump is programmed to move. This last method can cause mechanical damage to the internal carrier if more than a few hundred grams of force is used. If the holder cannot be moved away from the stop end easily by this method, then contact [techsupport@wpiinc.com](mailto:techsupport@wpiinc.com) for assistance. The pump may have to be returned for mechanical disassembly to correct this.

---

## Stalling

The UMP3 may stall for a number of reasons. The most likely cause is that the pump motor cannot push the syringe plunger for the following reasons:

- 1. More than 400 g is required to push the syringe plunger.** The syringe should not be a gas-tight (*i.e.*, Teflon-sealed) piston greater than 250 microliters in volume; this syringe type requires more force than the motor can push. If you require a large volume syringe (over 250  $\mu\text{L}$ ), please use a liquid-tight plunger.
- 2. Needle blockage.** The micropipette or the needle might be blocked by a tissue mass in or outside of the needle, or the needle tip may be too small for the programmed injection. Check for normal operation of the pump in air with and without the syringe attached. Too high a delivery rate through a too small tip can cause tissue damage and overtax the pump.
- 3. Syringe misalignment.** The syringe must be axially aligned to the UMP3 body in the clevises and the syringe plunger button must be centered in its holder to properly inject along the length of the syringe. A small misalignment of the syringe plunger can cause pulsating waves in the injection and an incorrect amount of delivery.
- 4. Mechanical damage.** If the UMP3 plunger carrier is loose (a condition which can be caused by overtravel), the pump must be returned to WPI for repair.

# Specifications

## UltraMicroPump III

Total Number of Steps (end to end) .....	20,000 (63 mm travel)
Minimum Dispensing Volume .....	0.58 nL/step ( <i>syringe dependent — see page 11</i> )
Linear Motion .....	3.175 $\mu$ /step
Plunger Position Error .....	< 0.5%
Pump Force .....	400 g
Syringe Diameters .....	5.5 mm to 9.0 mm
Maximum Step Rate .....	700 steps/sec ( <i>depending on syringe</i> )
Weight .....	325 grams (11.4 oz.)
Size .....	$\varnothing$ 32 mm x 190 mm ( $\varnothing$ 1.3 in. x 7.5 in.)
Power Requirements .....	12 VDC 2 amps, provided by Micro4

## Micro4 Controller

Power Requirements .....	12 V (1.6 A)
Dimensions .....	12.7 x 15.2 x 8.9 cm (5 x 6 x 3.5 in.)
Power Requirements .....	12 VDC from auto-switchable power supply (100-240 VAC input)

# References

**S.B. Mazzone, D.P. Geraghty** "Respiratory actions of tachykinins in the nucleus of the solitary tract: effect of neonatal capsaicin pretreatment" (2000) *British Journal of Pharmacology* **129**:6 pp1132-1139.

**B.L. Davidson, C.S. Stein, J.A. Heth, I. Martins, R.M. Kotin, T.A. Derksen, J. Zabner, A. Ghodsi, J.A. Chiorini** "Recombinant adeno-associated virus type 2, 4, and 5 vectors: Transduction of variant cell types and regions in the mammalian central nervous system" (2000) *Proceedings of the National Academy of Sciences of the United States of America* **97**:7 pp3428-3432.

**A.I. Brooks, et al.** "Reproducible and Efficient Murine CNS Gene Delivery Using a Microprocessor Controlled Injector" (1998) *Journal of Neuroscience Methods* **80** pp 137-147.

---

# Syringes

**UltraMicroPump III** is designed to be used with glass syringes having barrel diameters from 5.5 mm to 9 mm. WPI stocks the following syringes (with replaceable beveled needles):

<b>SGE0005RN*</b>	0.5 $\mu$ L 23 gauge (0.63 mm) 70 mm long (S) †
<b>SGE001RN*</b>	1.0 $\mu$ L 26 gauge (0.47 mm) 70 mm long cone (S) †

*\*The capacity of the above syringes is so small that the entire sample is contained within the needle. The plunger extends to the tip of the needle, displacing the full sample during injection — giving the syringe zero dead volume.*

<b>SGE005RN</b>	5.0 $\mu$ L 23 gauge (0.63 mm) 70 mm long (S) †
<b>SGE010RNS</b>	10 $\mu$ L 26 ga. 50mm needle (S)†
<b>SGE025RN</b>	25 $\mu$ L 25 ga. 50mm needle (S)†
<b>SGE050RN</b>	50 $\mu$ L Glass Microsyringe, 25 ga. needle (S)†
<b>SGE100RN</b>	100 $\mu$ L Glass Microsyringe, 25 ga. needle (S)†

## Replacement needles

<b>RN0005</b>	For Syringe SGE0005RN, 23 ga. (0.63 mm) 70 mm long
<b>RN001</b>	For Syringe SGE001RN, 26 ga. (0.47 mm cone) 70 mm long
<b>RN010</b>	For Syringe SGE010RN, 26 ga. (0.63 mm) 50 mm long, 5-pack
<b>RN025</b>	For Syringe SGE025RN, 25 ga. (0.63 mm) 50 mm long, 5-pack
<b>RN025</b>	For Syringe SGE050RN, 25 ga. (0.63 mm) 50 mm long, 5-pack
<b>RN025</b>	For Syringe SGE100RN, 25 ga. (0.63 mm) 50 mm long, 5-pack

## Syringes with luer fitting (no needle)

<b>ILS010LT</b>	10 $\mu$ L Gas tight Microsyringe, Luer Fitting (l)†
<b>ILS025LT</b>	25 $\mu$ L Gas tight Microsyringe, Luer Fitting (l)†
<b>SGE050TLL</b>	50 $\mu$ L Gas tight Microsyringe, Teflon Luer Lock Fitting (S)†
<b>SGE100TLL</b>	100 $\mu$ L Gas tight Microsyringe, Teflon Luer Lock Fitting (S)†
<b>SGE250TLL</b>	250 $\mu$ L Gas tight Microsyringe, Teflon Luer Lock Fitting (S)†

*Use of Gas tight Syringes above 250  $\mu$ L on the UMP3 is not recommended, Please use Liquid tight syringes for applications that require volumes greater than 250  $\mu$ L*

*† Hamilton is a trademark of Hamilton Co., SGE is a trademark of Scientific Glass Engineering., ILS is a trademark of Innovative Labor Systeme*

## Accessories

<b>15867</b>	Foot switch for Micro4
<b>40500</b>	RS232 cable for Micro4
<b>UMP3</b>	UltraMicroPump III
<b>300033</b>	Adaptor for Micro4 to Nanoliter 2000
<b>B203MC4</b>	Nanoliter 2000 and Micro4 controller
<b>B203XVY</b>	Nanoliter 2000 Injector (USA 110V power adapter included)
<b>503546</b>	Phillips screwdriver #0

## Replacement parts

<b>65134</b>	Mounting Bar
<b>65085</b>	Mounting Bar Locking Nut
<b>65015</b>	Collar Stop Nut

### ***For special connections:***

6-pin Miniature DIN plug (Digi-Key # CP-20600-ND) *Not available from WPI.*

---

## APPENDIX A: Nanoliter 2000/ Micro4 Volume Settings

When using the Micro4 to control injections with the Nanoliter 2000, take care when entering the injection volume. The Nanoliter 2000 injector's volume per step is based on the movement of the plunger wire inside a pulled glass pipette. This plunger moves 0.0005" (12.7  $\mu$ ) for each step of the motor. The volume of 2.3 nanoliters per step is based on the inside diameter of a 0.5 mm pipette and the 12.7  $\mu$  movement of the plunger wire.

### Setting the correct volume on the Micro4

Since the volume per step is 2.3 nanoliters, the volume to be entered on the Micro4 touch panel must be a multiple of 2.3.

**Example:** You wish to inject 100 nanoliters. The setting on the Micro4 panel will be calculated as  $100/2.3$  or 43.47 steps. The motor can only step in whole numbers, so the volume must be adjusted, up or down, to the nearest whole step value. Increasing to 44 steps times 2.3 gives a volume of 101.2 nL; decreasing to 43 steps times 2.3 gives a volume of 98.9 nL. One of these two volumes should be used to insure a proper injection. Leaving the value on the Micro4 at 100 nL will result in 98.9 nL being injected.

Difficulty can arise when the volume value is half or more of the next 2.3 nL step. For example, setting the Micro4 for an injection of 10 nL will result in an actual injection of 9.2 nL, produced by 4 whole steps of the injector; 5 whole steps would result in 11.5 nL. Entering a value of 11.0 nL in the controller, however, will generate a spurious value in the Micro4 display — 10.35 nL — but the actual injection will still be only 9.2 nL. To avoid this error, enter only multiples of 2.3 nL when calculating required volumes.

## APPENDIX B: Micro-stepping

The UMP3 has two user selectable stepping modes that each have both advantages and disadvantages. The purpose of this discussion is to assist the user in determining the best choice of mode for the application. For instructions on how to change stepping modes, see page 7. If you're in a hurry to determine which mode to use, skip down to the section titled "When should I Microstep?"

The discussion below uses several terms, which are in bold print in the text and are defined here:

**Volume per step:** For a given stepping mode and syringe size, this is the minimum volume increment that can be delivered by the UMP3.

**Step Angle:** The minimum rotational movement possible for a stepper motor, usually expressed in degrees.

**Stator:** A mechanically fixed set of electromagnetic coils arranged in a circumference on the inside diameter of the motor housing. The rotor is positioned within the field coils of the stator.

**Rotor:** A permanent magnetic structure bonded to the drive shaft of the motor. The poles of the rotor magnets react with the electro-magnetic-field generated in the stator, which forces the rotor to move.

**Normal Mode:** In Normal mode, the minimum step angle of the UMP3 is determined by half-stepping at  $3.75^\circ$ . This rotational movement is translated through the drive screw to be about  $3.18 \mu\text{m}$  of linear travel at the push block.

**Microstepping mode:** In Microstepping mode, the minimum step angle is conservatively rated at approximately  $0.47^\circ$ , and this translates to a linear motion at the push block of about 0.40

### Brief operational theory of stepper motors

The UMP3 drive system utilizes a bipolar stepper motor in an open loop configuration. A stepper motor converts electrical impulses into rotational movement. A stepper motor is a good choice for open loop applications because its rotational movement can be controlled in discrete increments that are precise, and repeatable. A stepper motor has a number of electromagnetic coils or "poles" that are arranged in a circle around the drive shaft. Generally speaking, the number of these "poles" determines the rotational resolution of the movement. The circle of electro-magnetic coils is collectively known as the **stator**. Centered within the stator is permanent magnet that is attached to a rotational shaft called the **rotor**. The rotor is connected to the lead screw, which is coupled to the push block, and converts rotational motion into the linear drive necessary to move the syringe plunger.

When a single or opposing pair of the stator coils is energized, the magnetic poles

---

of the rotor magnet move to align themselves with the energized coils. In practice, multiple coils are energized in a sequence by the motor drive circuitry, resulting in a rotational force on the rotor, which drives the lead screw.

## Microstepping

In a “normal” step sequence, when the motor is stopped, the magnetic poles of the rotor align themselves on axis with the plus and minus poles of the energized stator coils. However, it is possible to align the rotor BETWEEN the poles of two stator coils. This is known as half-stepping. Half stepping is accomplished by using standard position control techniques in the motor drive circuit, but the technical details are outside the scope of this discussion. Simplified, by controlling the relative phases of currents within the stator coils, an electromagnetic equilibrium is created such that the rotor is thus held in position between stator poles. In half stepping, the rotor is positioned halfway between two stator coils, and this effectively reduces the step angle of the rotor by 1/2, thus allowing a smaller step increment for injection. Using additional techniques, it is possible to achieve even finer sub-steps at 1/4, 1/8, 1/16, or even 1/64 of a step. This is referred to as microstepping. Although microstepping provides certain advantages, its implementation involves tradeoffs in torque, rotational speed, and precision. As a consequence, the dominant performance characteristics required for a given experiment should be considered before invoking the Microstepping mode on the UMP3.

## Advantages and Disadvantages of Microstepping

### Advantages:

Microstepping is useful for smoothing out undesirable pressure pulses that may be experienced in Normal step mode when injecting a very small volume or for injections that are performed over extended periods of time.

Microstepping offers improved precision when injecting a volume that is close to or less than the minimum volume per step in normal mode.

The UMP3 is quieter and has reduced vibration in Microstepping mode than it does in Normal step mode.

### Disadvantages:

1) Reduced torque. The microstepping technique results in reduced torque on the leadscrew. This can be as much as a 15 –30% reduction based on the step rate. The higher the step rate, the more the torque is reduced. In applications that demand maximum torque, such as when using a large volume gas tight syringe, microstepping is not a good choice.

2) Reduced speed. The Microstepping mode operates at 15 times slower speed than the Normal stepping mode.

## When should I Microstep?

Microstepping should be used when the calculated **volume per step** in Normal mode is larger than the desired volume to be injected, or when the volume per step in the Normal mode causes undesirable pressure pulsations when injecting at a low rate. Determining when pressure pulsations become undesirable is subjective, based on the requirements of the application. However, a useful rule of thumb is that if the injection is such that (5) or less minimum step volumes are injected per second, the injection can be considered pulsatile.

The examples below use calculations to illustrate the difference between Microstepping and Normal stepping. The first example shows the calculations for Normal stepping mode, and the second shows the calculations for Microstepping mode.

### Normal stepping example calculations

Suppose the experiment requires the injection of 1 nL from a 10  $\mu\text{L}$  syringe with a 60 mm stroke length. From the UMP3 specifications page, we obtain that the minimum linear step size in Normal mode is 3.175  $\mu\text{m}$  / step. Using this information and the scale volume of the syringe, we can calculate the minimum volume per step for Normal mode in nL:

1. Calculate the volume per distance traveled for the syringe in nL / step:

$$\frac{3.175 \mu\text{m}}{\text{step}} \times \frac{1 \text{ mm}}{1000 \mu\text{m}} \times \frac{10 \mu\text{L}}{60 \text{ mm}} \times \frac{1000 \text{ nL}}{1 \mu\text{L}} = \frac{0.529 \text{ nL}}{\text{step}}$$

2. Calculate the number of steps required to inject the desired volume.

It's important to understand that the UMP3 can only inject whole values of the minimum step volume, and will always perform the maximum number of steps possible to approximate the desired volume *without going over the target volume*.

$$\frac{1 \text{ nL}}{0.529 \text{ nL / step}} = 1.89 \text{ steps}$$

Remembering that the UMP3 can only inject the entire volume of the minimum step increment without going over the target volume, we see that one step increment injects 0.529 nL, and that two step increments will inject  $(2 \times 0.529 \text{ nL}) = 1.058 \text{ nL}$ . Since 1.058 nL exceeds the target value of 1 nL, only one step increment will be performed, and therefore the injected amount using the Normal step mode will be 0.529 nL.

---

## Microstepping Example calculations:

We will now perform the same calculations as above for injection of 1 nL from a 10  $\mu\text{L}$  syringe with a 60 mm stroke length using Microstepping. From the UMP3 specifications page, we obtain that the minimum linear step size in Microstepping mode is 0.4  $\mu\text{m}$  / step. Using this information and the scale volume of the syringe, we can calculate the minimum volume per step for Microstepping mode in nL:

1. Calculate the volume per distance traveled for the syringe in nL / step:

$$\frac{0.4 \mu\text{m}}{\text{step}} \times \frac{1 \text{ mm}}{1000 \mu\text{m}} \times \frac{10 \mu\text{L}}{60 \text{ mm}} \times \frac{1000 \text{ nL}}{1 \mu\text{L}} = \frac{0.067 \text{ nL}}{\text{step}}$$

2. Calculate the number of steps required to inject the desired volume.

$$\frac{1 \text{ nL}}{0.067 \text{ nL / step}} = 14.93 \text{ steps}$$

Remembering that the UMP3 can only inject aliquots of the minimum volume per step without exceeding the target volume, we see that the summation of 14 step increments injects 0.94 nL, which does not exceed the target value of 1 nL. From this example, we observe that using Microstepping more closely approximates the target volume than the Normal step mode.

# Declarations of Conformity



**WORLD PRECISION INSTRUMENTS, INC.**  
 175 Sarasota Center Boulevard  
 Sarasota, FL 34240-9258 USA  
 Telephone: (941) 371-1003 Fax: (941) 377-5428  
 e-mail wpi@wpiinc.com

## DECLARATION OF CONFORMITY

We: World Precision Instruments, Inc.  
 175 Sarasota Center Boulevard  
 Sarasota FL 34240-9258  
 USA

as the manufacturers of the apparatus listed, declare under sole responsibility that the product(s):

Title: UMC4

to which this declaration relates is/are in conformity with the following standards or other normative documents:

Safety: EN 61010-1:1993 (IEC 1010-1:1990)  
 EMC: EN 50081-1:1992  
 EN 50082-1:1992

and therefore conform(s) with the protection requirements of Council Directive 89/336/EEC relating to electromagnetic compatibility and Council Directive 73/23/EEC relating to safety requirements.

Issued on: 18<sup>th</sup> February 2009

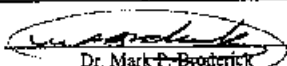
  
 Dr. Mark P. Broderick  
 President and CEO

World Precision Instruments, Inc.  
 175 Sarasota Center Boulevard  
 Sarasota, FL 34240-9258 USA

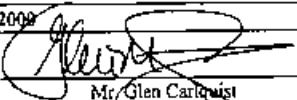
  
 Mr. Glen Carlquist  
 Production Manager

World Precision Instruments, Inc.  
 175 Sarasota Center Boulevard  
 Sarasota, FL 34240-9258 USA



**WORLD PRECISION INSTRUMENTS, INC.**

175 Sarasota Center Boulevard

Sarasota, FL 34240-9258 USA

Telephone: (941) 371-1003 Fax: (941) 377-5428

e-mail wpi@wpiinc.com

**DECLARATION OF CONFORMITY**

We: World Precision Instruments, Inc.  
175 Sarasota Center Boulevard  
Sarasota FL 34240-9258  
USA

as the manufacturer of the apparatus listed, declare under sole responsibility that the product:

**Title: ULTRA MICRO PUMP 3 (UMP 3)**

to which this declaration relates is in conformity with the following standards or other normative documents:

**Safety:** EN 61010-1:2001  
**EMC:** EN 61326-1: 2006  
EN 55011: 1998 + A2: 2002  
EN 61000-3-2: 2000  
EN 61000-3-3: 2001  
EN 61000-6-2: 2001

and therefore conforms with the protection requirements of Council Directive 2004/108/EC relating to electromagnetic compatibility and Council Directive 73/23/EEC relating to safety requirements.

**Issued on: February 23, 2007**

**Mr. Cliff Bredenberg**  
General Manager

World Precision Instruments, Inc.  
175 Sarasota Center Boulevard  
Sarasota, FL 34240-9258 USA

**Mr. Glen Cariquist**  
Vice President of Manufacturing

World Precision Instruments, Inc.  
175 Sarasota Center Boulevard  
Sarasota, FL 34240-9258 USA

## **Warranty**

WPI (World Precision Instruments, Inc.) warrants to the original purchaser that this equipment, including its components and parts, shall be free from defects in material and workmanship for a period of one year\* from the date of receipt. WPI's obligation under this warranty shall be limited to repair or replacement, at WPI's option, of the equipment or defective components or parts upon receipt thereof f.o.b. WPI, Sarasota, Florida U.S.A. Return of a repaired instrument shall be f.o.b. Sarasota.

The above warranty is contingent upon normal usage and does not cover products which have been modified without WPI's approval or which have been subjected to unusual physical or electrical stress or on which the original identification marks have been removed or altered. The above warranty will not apply if adjustment, repair or parts replacement is required because of accident, neglect, misuse, failure of electric power, air conditioning, humidity control, or causes other than normal and ordinary usage.

To the extent that any of its equipment is furnished by a manufacturer other than WPI, the foregoing warranty shall be applicable only to the extent of the warranty furnished by such other manufacturer. This warranty will not apply to appearance terms, such as knobs, handles, dials or the like.

WPI makes no warranty of any kind, express or implied or statutory, including without limitation any warranties of merchantability and/or fitness for a particular purpose. WPI shall not be liable for any damages, whether direct, indirect, special or consequential arising from a failure of this product to operate in the manner desired by the user. WPI shall not be liable for any damage to data or property that may be caused directly or indirectly by use of this product.

## **Claims and Returns**

Inspect all shipments upon receipt. Missing cartons or obvious damage to cartons should be noted on the delivery receipt before signing. Concealed loss or damage should be reported at once to the carrier and an inspection requested. All claims for shortage or damage must be made within ten (10) days after receipt of shipment. Claims for lost shipments must be made within thirty (30) days of receipt of invoice or other notification of shipment. Please save damaged or pilfered cartons until claim is settled. In some instances, photographic documentation may be required. Some items are time-sensitive; WPI assumes no extended warranty or any liability for use beyond the date specified on the container

Do not return any goods to us without obtaining prior approval and instructions from our Returns Department. Goods returned (unauthorized) by collect freight may be refused. Goods accepted for restocking will be exchanged or credited to your WPI account. Goods returned which were ordered by customers in error are subject to a 25% restocking charge. Equipment which was built as a special order cannot be returned.

## **Repairs**

Contact our Customer Service Department for assistance in the repair of apparatus. Do not return goods until instructions have been received. Returned items must be securely packed to prevent further damage in transit. The Customer is responsible for paying shipping expenses, including adequate insurance on all items returned for repairs. Identification of the item(s) by model number, name, as well as complete description of the difficulties experienced should be written on the repair purchase order and on a tag attached to the item.

*\* Electrodes, batteries and other consumable parts are warranted for 30 days only from the date on which the customer receives these items.*

# WARRANTY REGISTRATION

Please complete this registration form and return it by mail or Fax to receive Technical Support and Customer Services within the terms of our Warranty. If you prefer, you may also fill out the on-line registration form at [www.wpiinc.com/warranty](http://www.wpiinc.com/warranty)

<input type="checkbox"/> DR	<input type="checkbox"/> PROF	<input type="checkbox"/> MR	<input type="checkbox"/> MS
FIRST NAME	LAST NAME		
<input type="text"/>	<input type="text"/>		
COMPANY / INSTITUTION			
<input type="text"/>			
DEPARTMENT			
<input type="text"/>			
ADDRESS			
<input type="text"/>			
CITY	STATE	ZIP	
<input type="text"/>	<input type="text"/>	<input type="text"/>	
COUNTRY	INTL MAIL CODE		
<input type="text"/>	<input type="text"/>		
TELEPHONE	FAX		
<input type="text"/>	<input type="text"/>		
E-MAIL			
<input type="text"/>			

## PRODUCT INFORMATION

Product Name or Model \_\_\_\_\_

Invoice Number \_\_\_\_\_

Serial number \_\_\_\_\_ Purchase Date \_\_\_\_\_

What is your primary application or area of research? \_\_\_\_\_

\_\_\_\_\_

May we add your name to our Users Group List to which we occasionally refer other users or prospective users?	Would you like to receive e-mail updates about this and other WPI products?
<input type="checkbox"/> YES <input type="checkbox"/> NO	<input type="checkbox"/> YES <input type="checkbox"/> NO

**Privacy Policy**  
The personal information you provide to WPI is treated with care to ensure safety, security and confidentiality. WPI does not sell, trade, rent, or otherwise provide customer information to third parties. WPI has implemented security features and strict policy guidelines to safeguard the privacy of customer information from unauthorized access or improper use.

World Precision Instruments, Inc. • 175 Sarasota Center Boulevard • Sarasota FL 34240-9258  
Tel.: 941-371-1003 • Fax: 941-377-5428 • Order Toll-Free: 866-606-1974





## ***World Precision Instruments, Inc.***

### **USA**

International Trade Center, 175 Sarasota Center Blvd., Sarasota FL 34240-9258  
Tel: 941-371-1003 • Fax: 941-377-5428 • E-mail: sales@wpiinc.com

### **UK**

1 Hunting Gate, Hitchin, Hertfordshire SG4 0TJ  
Tel: 44 (0)1462 424700 • Fax: 44 (0)1462 424701 • E-mail: wpiuk@wpi-europe.com

### **Germany**

Zossener Str. 55, 10961 Berlin  
Tel: 030-6188845 • Fax: 030-6188670 • E-mail: wpide@wpi-europe.com

### **China & Hong Kong**

WPI Shanghai Trading Co., Ltd.  
Rm 20a, No8 Dong Fang Rd., Lu Jia Zui Financial District, Shanghai PRC  
Tel: +86 688 85517 • E-mail: chinasales@china.wpiinc.com

### **Internet**

[www.wpiinc.com](http://www.wpiinc.com)